

SHURE[®]

LEGENDARY
PERFORMANCE™

A Shure Educational Publication

MICROPHONE TECHNIQUES

LIVE SOUND REINFORCEMENT





Table of Contents

Introduction	4
Microphone Characteristics	5
Musical Instrument Characteristics.....	11
Acoustic Characteristics	14
Microphone Placement.....	22
Stereo Microphone Techniques.....	32
Microphone Selection Guide	34
Glossary	35



Live Sound

Introduction

Microphone techniques (the selection and placement of microphones) have a major influence on the audio quality of a sound reinforcement system. For reinforcement of musical instruments, there are several main objectives of microphone techniques: to maximize pick-up of suitable sound from the desired instrument, to minimize pick-up of undesired sound from instruments or other sound sources, and to provide sufficient gain-before-feedback. "Suitable" sound from the desired instrument may mean either the natural sound of the instrument or some particular sound quality which is appropriate for the application. "Undesired" sound may mean the direct or ambient sound from other nearby instruments or just stage and background noise. "Sufficient" gain-before-feedback means that the desired instrument is reinforced at the required level without ringing or feedback in the sound system.

Obtaining the proper balance of these factors may involve a bit of give-and-take with each. In this guide, Shure application and development engineers suggest a variety of microphone techniques for musical instruments to achieve these objectives. In order to provide some background for these techniques it is useful to understand some of the important characteristics of microphones, musical instruments and acoustics.

Introduction



Microphone Characteristics

The most important characteristics of microphones for live sound applications are their operating principle, frequency response and directionality. Secondary characteristics are their electrical output and actual physical design.

Operating principle - The type of *transducer* inside the microphone, that is, how the microphone picks up sound and converts it into an electrical signal.

A transducer is a device that changes energy from one form into another, in this case, acoustic energy into electrical energy. The operating principle determines some of the basic capabilities of the microphone. The two most common types are Dynamic and Condenser.

Dynamic microphones employ a diaphragm/ voice coil/magnet assembly which forms a miniature sound-driven electrical generator. Sound waves strike a thin plastic membrane (diaphragm) which vibrates in response. A small coil of wire (voice coil) is attached to the rear of the diaphragm and vibrates with it. The voice coil itself is surrounded by a magnetic field created by a small permanent magnet. It is the motion of the voice coil in this magnetic field which generates the electrical signal corresponding to the sound picked up by a dynamic microphone.

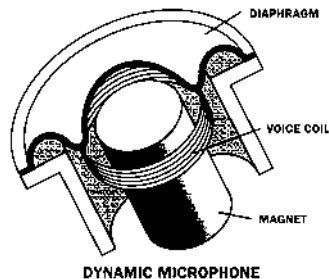

Dynamic microphones have relatively simple construction and are therefore economical and rugged. They can provide excellent sound quality and good specifications in all areas of microphone performance. In particular, they can handle extremely high sound levels: it is almost impossible to overload a dynamic microphone. In addition, dynamic microphones are relatively unaffected by extremes of temperature or humidity. Dynamics are the type most widely used in general sound reinforcement.

Condenser microphones are based on an electrically-charged diaphragm/backplate assembly which forms a sound-sensitive capacitor. Here, sound waves vibrate a very thin metal or metal-coated-plastic diaphragm. The diaphragm is mounted just in front of a rigid metal or metal-coated-ceramic backplate. In electrical terms this assembly or element is known as a capacitor (historically

called a “condenser”), which has the ability to store a *charge* or voltage. When the element is charged, an electric field is created between the diaphragm and the backplate, proportional to the spacing between them. It is the variation of this spacing, due to the motion of the diaphragm relative to the backplate, that produces the electrical signal corresponding to the sound picked up by a condenser microphone.

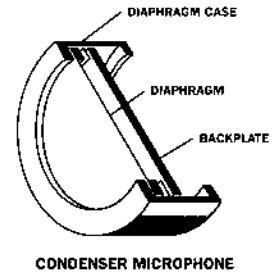

The construction of a condenser microphone must include some provision for maintaining the electrical charge or *polarizing* voltage. An *electret* condenser microphone has a permanent charge, maintained by a special material deposited on the backplate or on the diaphragm. Non-electret types are charged (polarized) by means of an external power source. The majority of condenser microphones for sound reinforcement are of the electret type.

All condensers contain additional active circuitry to allow the electrical output of the element to be used with typical microphone inputs. This requires that all condenser microphones be powered: either by batteries or by *phantom* power (a method of supplying power to a microphone through the microphone cable itself). There are two potential limitations of condenser microphones due to the additional circuitry: first, the electronics produce a small amount of noise; second, there is a limit to the maximum signal level that the electronics can handle. For this reason, condenser microphone specifications always include a noise figure and a maximum sound level. Good designs, however, have very low noise levels and are also capable of very wide dynamic range.

Condenser microphones are more complex than dynamics and tend to be somewhat more costly. Also, condensers may be adversely affected by extremes of temperature and humidity which can cause them to become noisy or fail temporarily. However, condensers can readily be made with higher sensitivity and can provide a smoother, more natural sound, particularly at high frequencies. Flat frequency response and extended frequency range are much easier to obtain in a condenser. In addition, condenser microphones can be made very small without significant loss of performance.

Microphone Techniques for **LIVE SOUND**

Phantom Power

Phantom power is a DC voltage (usually 12-48 volts) used to power the electronics of a condenser microphone. For some (non-electret) condensers it may also be used to provide the polarizing voltage for the element itself. This voltage is supplied through the microphone cable by a mixer equipped with phantom power or by some type of in-line external source. The voltage is equal on Pin 2 and Pin 3 of a typical balanced, XLR-type connector. For a 48 volt phantom source, for example, Pin 2 is 48 VDC and Pin 3 is 48 VDC, both with respect to Pin 1 which is ground (shield).

Because the voltage is exactly the same on Pin 2 and Pin 3, phantom power will have no effect on balanced dynamic microphones: no current will flow since there is no voltage difference across the output. In fact, phantom power supplies have current limiting which will prevent damage to a dynamic microphone even if it is shorted or miswired. In general, balanced dynamic microphones can be connected to phantom powered mixer inputs with no problem.

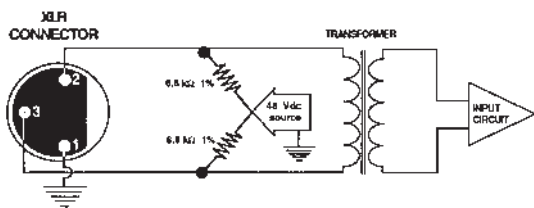

lightweight condenser diaphragm. It also takes longer for the dynamic diaphragm to stop moving in comparison to the condenser diaphragm. Thus, the dynamic transient response is not as good as the condenser transient response. This is similar to two vehicles in traffic: a truck and a sports car. They may have equal power engines but the truck weighs much more than the car. As traffic flow changes, the sports car can accelerate and brake very quickly, while the semi accelerates and brakes very slowly due to its greater weight. Both vehicles follow the overall traffic flow but the sports car responds better to sudden changes.

Pictured here are two studio microphones responding to the sound impulse produced by an electric spark: condenser mic on top, dynamic mic on bottom. It is evident that it takes almost twice as long for the dynamic microphone to respond to the sound. It also takes longer for the dynamic to stop moving after the impulse has passed (notice the ripple on the second half of the graph). Since condenser microphones generally have better transient response than dynamics, they are better suited for instruments that have very sharp attack or extended high frequency output such as cymbals. It is this transient response difference that causes condenser mics to have a more crisp, detailed sound and dynamic mics to have a more mellow, rounded sound.

Transient Response

Transient response refers to the ability of a microphone to respond to a rapidly changing sound wave. A good way to understand why dynamic and condenser mics sound different is to understand the differences in their transient response.

In order for a microphone to convert sound energy into electrical energy, the sound wave must physically move the diaphragm of the microphone. The amount of time it takes for this movement to occur depends on the weight (or mass) of the diaphragm. For instance, the diaphragm and voice coil assembly of a dynamic microphone may weigh up to 1000 times more than the diaphragm of a condenser microphone. It takes longer for the heavy dynamic diaphragm to begin moving than for the

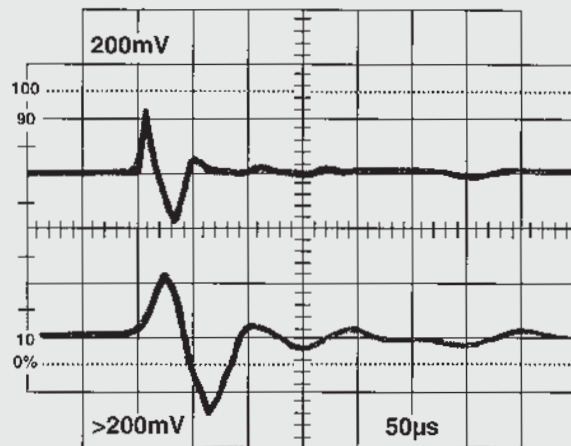

Condenser/dynamic scope photo

The decision to use a condenser or dynamic microphone depends not only on the sound source and the sound reinforcement system but on the physical setting as well. From a practical standpoint, if the microphone will be used in a severe environment such as a rock and roll club or for outdoor sound, dynamic types would be a good choice. In a more controlled environment such as a concert hall or theatrical setting, a condenser microphone might be preferred for many sound sources, especially when the highest sound quality is desired.

Frequency response - The output level or sensitivity of the microphone over its operating range from lowest to highest frequency.

Virtually all microphone manufacturers list the frequency response of their microphones over a range, for example 50 - 15,000 Hz. This usually corresponds with a graph that indicates output level relative to frequency. The graph has frequency in Hertz (Hz) on the x-axis and relative response in decibels (dB) on the y-axis.

A microphone whose output is equal at all frequencies has a *flat* frequency response.

Flat response microphones typically have an extended frequency range. They reproduce a variety of sound sources without changing or *coloring* the original sound.

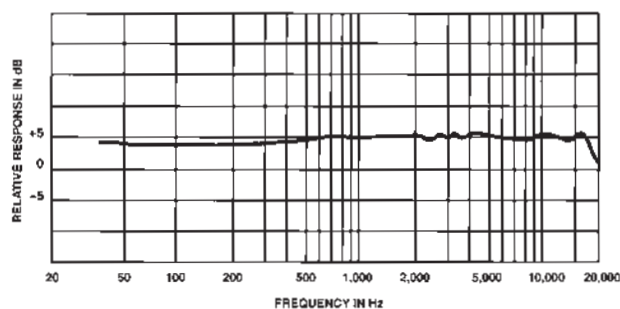

Flat frequency response

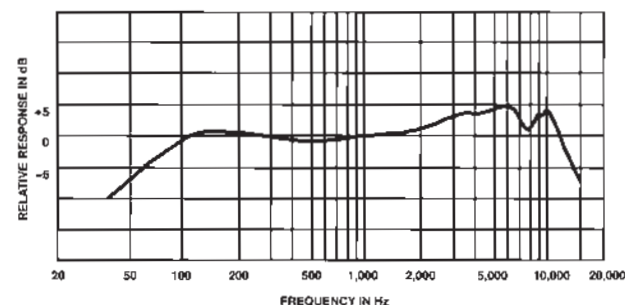

Shaped frequency response

A microphone whose response has peaks or dips in certain frequency areas exhibits a *shaped* response.

A shaped response is usually designed to enhance a sound source in a particular application.

For instance, a microphone may have a peak in the 2 - 8 kHz range to increase intelligibility for live vocals. This shape is called a *presence* peak or rise. A microphone may also be designed to be less sensitive to certain other frequencies. One example is reduced low frequency response (low end roll-off) to minimize unwanted “boominess” or stage rumble.

The Decibel

The decibel (dB) is an expression often used in electrical and acoustic measurements. The decibel is a number that represents a ratio of two values of a quantity such as voltage. It is actually a logarithmic ratio whose main purpose is to scale a large measurement range down to a much smaller and more useable range. The form of the decibel relationship for voltage is:

$$\text{dB} = 20 \times \log(V1/V2)$$

where 20 is a constant, V1 is one voltage, V2 is the other voltage, and log is logarithm base 10.

Examples:

What is the relationship in decibels between 100 volts and 1 volt?

$$\text{dB} = 20 \times \log(100/1)$$

$$\text{dB} = 20 \times \log(100)$$

$$\text{dB} = 20 \times 2 \quad (\text{the log of } 100 \text{ is } 2)$$

$$\text{dB} = 40$$

That is, 100 volts is 40dB greater than 1 volt.

What is the relationship in decibels between 0.001 volt and 1 volt?

$$\text{dB} = 20 \times \log(0.001/1)$$

$$\text{dB} = 20 \times \log(0.001)$$

$$\text{dB} = 20 \times (-3) \quad (\text{the log of } .001 \text{ is } -3)$$

$$\text{dB} = -60$$

That is, 0.001 volt is 60dB less than 1 volt.

Similarly:

if one voltage is equal to the other they are 0dB different

if one voltage is twice the other they are 6dB different

if one voltage is ten times the other they are 20dB different

Microphone Techniques for LIVE SOUND

Since the decibel is a ratio of two values, there must be an explicit or implicit reference value for any measurement given in dB. This is usually indicated by a suffix on the decibel value such as: dBV (reference to 1 volt which is 0dBV) or dB SPL (reference to 0.0002 microbar which is 0dB Sound Pressure Level)

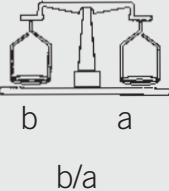
1. Compare	2. Compress	3. scale (x 20)
	$10^0=1$	0
	$10^1=10$	20
	$10^2=100$	40
	$10^3=1000$	60
	$10^4=10,000$	80
	$10^5=100,000$	100
	$10^6=1,000,000$	120

Decibel scale
for dBV or dB SPL

One reason that the decibel is so useful in certain audio measurements is that this scaling function closely approximates the behavior of human hearing sensitivity. For example, a change of 1dB SPL is about the smallest difference in loudness that can be perceived while a 3dB SPL change is generally noticeable. A 6dB SPL change is quite noticeable and finally, a 10dB SPL change is perceived as "twice as loud."

The choice of flat or shaped response microphones again depends on the sound source, the sound system and the environment. Flat response microphones are usually desirable to reproduce instruments such as acoustic guitars or pianos, especially with high quality sound systems. They are also common in stereo miking and *distant pickup* applications where the microphone is more than a few feet from the sound source: the absence of response peaks minimizes feedback and contributes to a more natural sound. On the other hand, shaped response microphones are preferred for closeup vocal use and for certain instruments such as drums and guitar amplifiers which may benefit from response enhancements for *presence* or *punch*. They are also useful for reducing pickup of unwanted sound and noise outside the frequency range of an instrument.

Directionality - A microphone's sensitivity to sound relative to the direction or angle from which the sound arrives.

There are a number of different directional patterns found in microphone design. These are typically plotted in a polar pattern to graphically display the directionality of the microphone. The polar pattern shows the variation in sensitivity 360 degrees around the microphone, assuming that the microphone is in the center and that 0 degrees represents the front of the microphone.

The three basic directional types of microphones are omnidirectional, unidirectional, and bidirectional.

The **omnidirectional** microphone has equal output or sensitivity at all angles. Its coverage angle is a full 360 degrees. An omnidirectional microphone will pick up the maximum amount of ambient sound. In live sound situations an omni should be placed very close to the sound source to pick up a useable balance between direct sound and ambient sound. In addition, an omni cannot be *aimed* away from undesired sources such as PA speakers which may cause feedback.

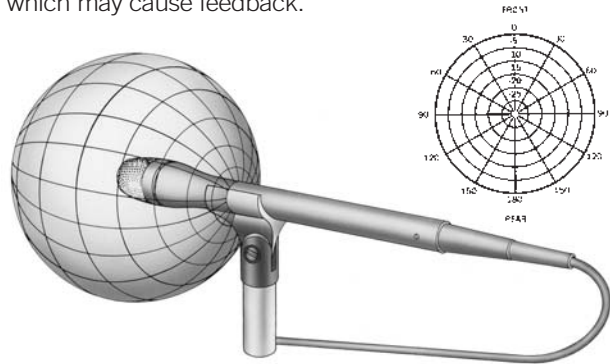

Omnidirectional

The **unidirectional** microphone is most sensitive to sound arriving from one particular direction and is less sensitive at other directions. The most common type is a cardioid (heart-shaped) response. This has the most sensitivity at 0 degrees (on-axis) and is least sensitive at 180 degrees (off-axis). The effective coverage or pickup angle of a cardioid is about 130 degrees, that is up to about 65 degrees off axis at the front of the microphone. In addition, the cardioid mic picks up only about one-third as much ambient sound as an omni. Unidirectional microphones isolate the desired on-axis sound from both unwanted off-axis sound and from ambient noise.

Microphone Techniques for **LIVE SOUND**

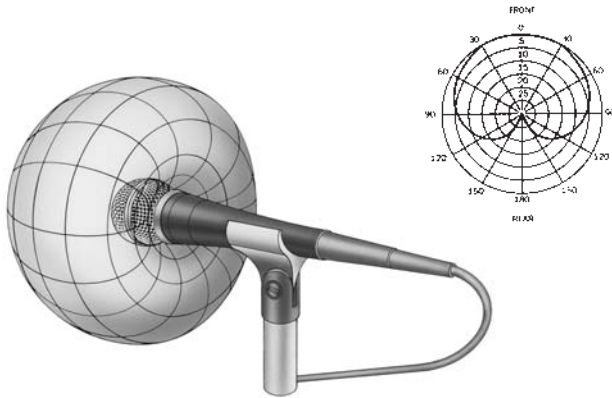

Cardioid

For example, the use of a cardioid microphone for a guitar amplifier which is near the drum set is one way to reduce bleed-through of drums into the reinforced guitar sound.

Unidirectional microphones have several variations on the cardioid pattern. Two of these are the supercardioid and hypercardioid.

Both patterns offer narrower front pickup angles than the cardioid (115 degrees for the supercardioid and 105 degrees for the hypercardioid) and also greater rejection of ambient sound. While the cardioid is least sensitive at the rear (180 degrees off-axis) the least sensitive direction is at 126 degrees off-axis for the supercardioid and 110 degrees for the hypercardioid. When placed properly they can provide more focused pickup and less ambient noise than the cardioid pattern, but they have some pickup directly at the rear, called a rear lobe. The rejection at the rear is -12 dB for the supercardioid and only -6 dB for the hypercardioid. A good cardioid type has at least 15-20 dB of rear rejection.

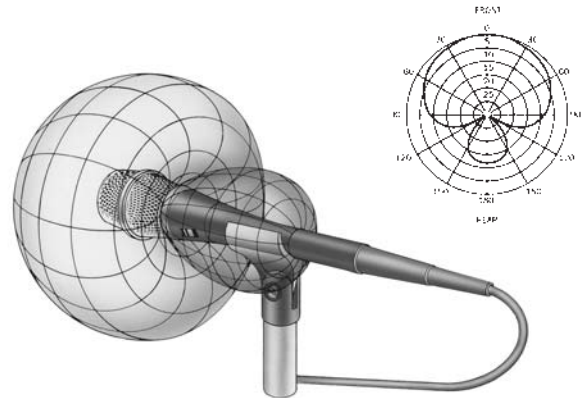

Supercardioid

The **bidirectional microphone** has maximum sensitivity at both 0 degrees (front) and at 180 degrees (back). It has the least amount of output at 90 degree angles (sides). The coverage or pickup angle is only about 90 degrees at both the front and the rear. It has the same amount of ambient pickup as the cardioid. This mic could be used for picking up two opposing sound sources, such as a vocal duet. Though rarely found in sound reinforcement they are used in certain stereo techniques, such as M-S (mid-side).

Microphone Polar Patterns Compared

CHARACTERISTIC	OMNI-DIRECTIONAL	CARDIOID	SUPER-CARDIOID	HYPER-CARDIOID	BI-DIRECTIONAL
POLAR RESPONSE PATTERN					
COVERAGE ANGLE	360°	131°	115°	105°	90°
ANGLE OF MAXIMUM REJECTION (null angle)	—	180°	126°	110°	90°
REAR REJECTION (relative to front)	0	25 dB	12 dB	6 dB	0
AMBIENT SOUND SENSITIVITY (relative to omni)	100%	33%	27%	25%	33%
DISTANCE FACTOR (relative to omni)	1	1.7	1.9	2	1.7

Microphone Polar Patterns Compared

Microphone Techniques for LIVE SOUND

Using Directional Patterns to Reject Unwanted Sources

In sound reinforcement, microphones must often be located in positions where they may pick up unintended instrument or other sounds. Some examples are: individual drum mics picking up adjacent drums, vocal mics picking up overall stage noise, and vocal mics picking up monitor speakers. In each case there is a desired sound source and one or more undesired sound sources. Choosing the appropriate directional pattern can help to maximize the desired sound and minimize the undesired sound.

Although the direction for maximum pickup is usually obvious (on-axis) the direction for least pickup varies with microphone type. In particular, the cardioid is least sensitive at the rear (180 degrees off-axis) while the supercardioid and hypercardioid types actually have some rear pickup. They are least sensitive at 125 degrees off-axis and 110 degrees off axis respectively.

For example, when using floor monitors with vocal mics, the monitor should be aimed directly at the rear axis of a cardioid microphone for maximum gain-before-feedback. When using a supercardioid, however, the monitor should be positioned somewhat off to the side (55 degrees off the rear axis) for best results. Likewise, when using supercardioid or hypercardioid types on drum kits be aware of the rear pickup of these mics and angle them accordingly to avoid pickup of other drums or cymbals.

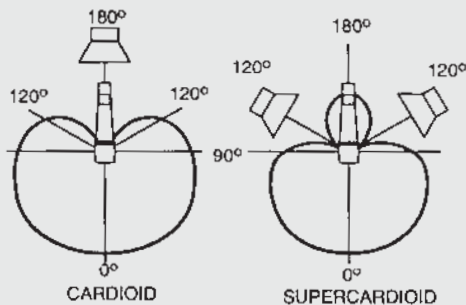

Monitor speaker placement for maximum rejection:
cardioid and supercardioid

Other directional related microphone characteristics:

Ambient sound rejection - Since unidirectional microphones are less sensitive to off-axis sound than omnidirectional types they pick up less overall ambient or stage sound. Unidirectional mics should be used to control ambient noise pickup to get a cleaner mix.

Distance factor - Because directional microphones pick up less ambient sound than omnidirectional types they may be used at somewhat greater distances from a sound source and still achieve the same balance between the direct sound and background or ambient sound. An omni should be placed closer to the sound source than a uni—about half the distance—to pick up the same balance between direct sound and ambient sound.

Off-axis coloration - Change in a microphone's frequency response that usually gets progressively more noticeable as the arrival angle of sound increases. High frequencies tend to be lost first, often resulting in "muddy" off-axis sound.

Proximity effect - With unidirectional microphones, bass response increases as the mic is moved closer (within 2 feet) to the sound source. With close-up unidirectional microphones (less than 1 foot), be aware of proximity effect and roll off the bass until you obtain a more natural sound. You can (1) roll off low frequencies on the mixer, or (2) use a microphone designed to minimize proximity effect, or (3) use a microphone with a bass rolloff switch, or (4) use an omnidirectional microphone (which does not exhibit proximity effect).

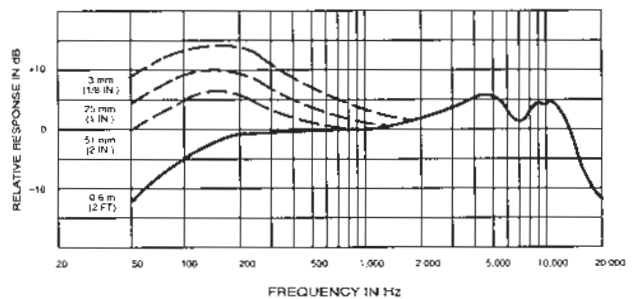

Proximity effect graph

Unidirectional microphones can not only help to isolate one voice or instrument from other singers or instruments, but can also minimize feedback, allowing higher gain. For these reasons, unidirectional microphones are preferred over omnidirectional microphones in almost all sound reinforcement applications.

The **electrical output** of a microphone is usually specified by level, impedance and wiring configuration. Output level or sensitivity is the level of the electrical signal from the microphone for a given input sound level. In general, condenser microphones have higher sensitivity than dynamic types. For weak or distant sounds a high sensitivity microphone is desirable while loud or close-up sounds can be picked up well by lower-sensitivity models.

The output impedance of a microphone is roughly equal to the electrical resistance of its output: 150-600 ohms for low impedance (low-Z) and 10,000 ohms or more for high impedance.(high-Z). The practical concern is that low impedance microphones can be used with cable lengths of 1000 feet or more with no loss of quality while high impedance types exhibit noticeable high frequency loss with cable lengths greater than about 20 feet.

Finally, the wiring configuration of a microphone may be balanced or unbalanced. A balanced output carries the signal on two conductors (plus shield). The signals on each conductor are the same level but opposite polarity (one signal is positive when the other is negative). A balanced microphone input amplifies only the difference between the two signals and rejects any part of the signal which is the same in each conductor. Any electrical noise or hum picked up by a balanced (two-conductor) cable tends to be identical in the two conductors and is therefore rejected by the balanced input while the equal but opposite polarity original signals are amplified. On the other hand, an unbalanced microphone output carries its signal on a single conductor (plus shield) and an unbalanced microphone input amplifies any signal on that conductor. Such a combination will be unable to reject any electrical noise which has been picked up by the cable. Balanced, low-impedance microphones are therefore recommended for nearly all sound reinforcement applications.

The **physical design** of a microphone is its mechanical and operational design. Types used in sound reinforcement include: handheld, headworn, lavalier, overhead, stand-mounted, instrument-mounted and surface-mounted designs. Most of these are available in

How a Balanced Input Works

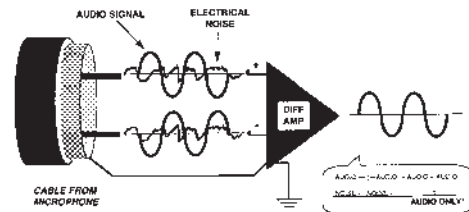

How an Unbalanced Input Works

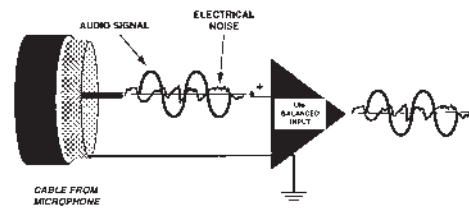

a choice of operating principle, frequency response, directional pattern and electrical output. Often the physical design is the first choice made for an application. Understanding and choosing the other characteristics can assist in producing the maximum quality microphone signal and delivering it to the sound system with the highest fidelity.

Musical Instrument Characteristics

Some background information on characteristics of musical instruments may be helpful. Instruments and other sound sources are characterized by their frequency output, by their directional output and by their dynamic range.

Frequency output - the span of fundamental and harmonic frequencies produced by an instrument, and the balance or relative level of those frequencies.

Musical instruments have overall frequency ranges as found in the chart below. The dark section of each line indicates the range of fundamental frequencies and the shaded section represents the range of the highest harmonics or overtones of the instrument. The fundamental frequency establishes the basic pitch of a note played by an instrument while the harmonics produce the *timbre* or characteristic tone.

Microphone Techniques for LIVE SOUND

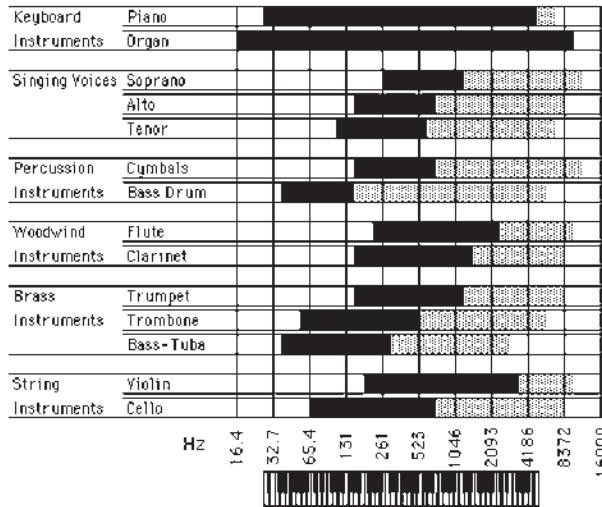

Instrument frequency ranges

It is this timbre that distinguishes the sound of one instrument from another. In this manner, we can tell whether a piano or a trumpet just played that C note. The following graphs show the levels of the fundamental and harmonics associated with a trumpet and an oboe each playing the same note.

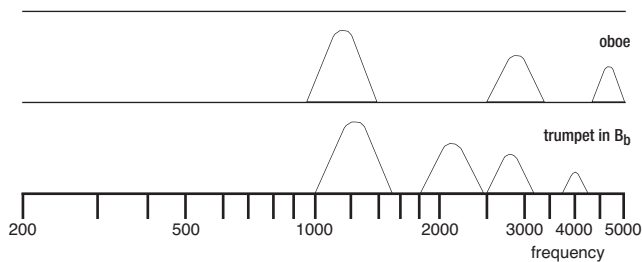

Instrument spectra comparison

The number of harmonics along with the relative level of the harmonics is noticeably different between these two instruments and provides each instrument with its own unique sound.

A microphone which responds evenly to the full range of an instrument will reproduce the most natural sound from an instrument. A microphone which responds unevenly or to less than the full range will alter the sound of the instrument, though this effect may be desirable in some cases.

Directional output - the three-dimensional pattern of sound waves radiated by an instrument.

A musical instrument radiates a different tone quality (timbre) in every direction, and each part of the instrument produces a different timbre. Most musical instruments are designed to sound best at a distance, typically two or more feet away. At this distance, the sounds of the various parts of the instrument combine into a pleasing composite. In addition, many instruments produce this balanced sound only in a particular direction. A microphone placed at such distance and direction tends to pick up a natural or well-balanced tone quality.

On the other hand, a microphone placed close to the instrument tends to emphasize the part of the instrument that the microphone is near. The resulting sound may not be representative of the instrument as a whole. Thus, the reinforced tonal balance of an instrument is strongly affected by the microphone position relative to the instrument.

Unfortunately, it is difficult, if not impossible, to place a microphone at the "natural sounding" distance from an instrument in a sound reinforcement situation without picking up other (undesired) sounds and/or acoustic feedback. Close microphone placement is usually the only practical way to achieve sufficient isolation and gain-before-feedback. But since the sound picked up close to a source can vary significantly with small changes in microphone position, it is very useful to experiment with microphone location and orientation. In some cases more than one microphone may be required to get a good sound from a large instrument such as a piano.

Instrument Loudspeakers

Another instrument with a wide range of characteristics is the loudspeaker. Anytime you are placing microphones to pick up the sound of a guitar or bass cabinet you are confronted with the acoustic nature of loudspeakers. Each individual loudspeaker type is directional and displays different frequency characteristics at different angles and distances. The sound from a loudspeaker tends to be almost omnidirectional at low frequencies but becomes very directional at high frequencies. Thus, the sound on-axis at the center of a speaker usually has the most “bite” or high-end, while the sound produced off-axis or at the edge of the speaker is more “mellow” or bassy. A cabinet with multiple loudspeakers has an even more complex output, especially if it has different speakers for bass and treble. As with most acoustic instruments the desired sound only develops at some distance from the speaker.

Sound reinforcement situations typically require a close-mic approach. A unidirectional dynamic microphone is a good first choice here: it can handle the high level and provide good sound and isolation. Keep in mind the proximity effect when using a uni close to the speaker: some bass boost will be likely. If the cabinet has only one speaker a single microphone should pick up a suitable sound with a little experimentation. If the cabinet has multiple speakers of the same type it is typically easiest to place the microphone to pick up just one speaker. Placing the microphone between speakers can result in strong phase effects though this may be desirable to achieve a particular tone. However, if the cabinet is stereo or has separate bass and treble speakers multiple microphones may be required.

Placement of loudspeaker cabinets can also have a significant effect on their sound. Putting cabinets on carpets can reduce brightness, while raising them off the floor can reduce low end. Open-back cabinets can be miked from behind as well as from the front. The distance from the cabinet to walls or other objects can also vary the sound. Again, experiment with the microphone(s) and placement until you have the sound that you like!

Dynamic range - the range of volume of an instrument from its softest to its loudest level.

The dynamic range of an instrument determines the specifications for sensitivity and maximum input capability of the intended microphone. Loud instruments such as drums, brass and amplified guitars are handled well by dynamic microphones which can withstand high sound levels and have moderate sensitivity. Softer instruments such as flutes and harpsichords can benefit from the higher sensitivity of condensers. Of course, the farther the microphone is placed from the instrument the lower the level of sound reaching the microphone.

In the context of a live performance, the relative dynamic range of each instrument determines how much sound reinforcement may be required. If all of the instruments are fairly loud, and the venue is of moderate size with good acoustics, no reinforcement may be necessary. On the other hand, if the performance is in a very large hall or outdoors, even amplified instruments may need to be further reinforced. Finally, if there is a substantial difference in dynamic range among the instruments, such as an acoustic guitar in a loud rock band, the microphone techniques (and the sound system) must accommodate those differences. Often, the maximum volume of the overall sound system is limited by the maximum gain-before-feedback of the softest instrument.

An understanding of the frequency output, directional output, and dynamic range characteristics of musical instruments can help significantly in choosing suitable microphones, placing them for best pickup of the desired sound and minimizing feedback or other undesired sounds.

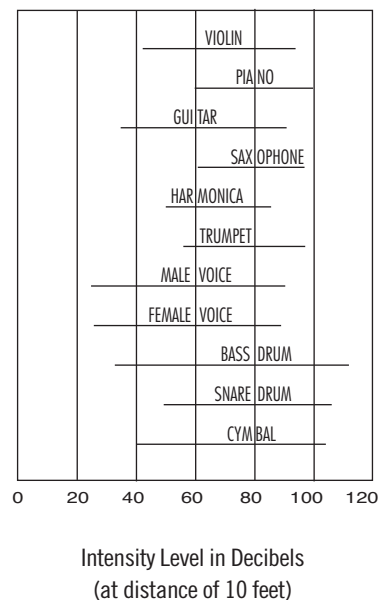

Microphone Techniques for **LIVE SOUND**

Acoustic Characteristics

Sound Waves

Sound moves through the air like waves in water. Sound waves consist of pressure variations traveling through the air. When the sound wave travels, it compresses air molecules together at one point. This is called the high pressure zone or positive component(+). After the compression, an expansion of molecules occurs. This is the low pressure zone or negative component(-). This process continues along the path of the sound wave until its energy becomes too weak to hear. The sound wave of a pure tone traveling through air would appear as a smooth, regular variation of pressure that could be drawn as a sine wave.

Frequency, wavelength and the speed of sound

The frequency of a sound wave indicates the rate of pressure variations or cycles.

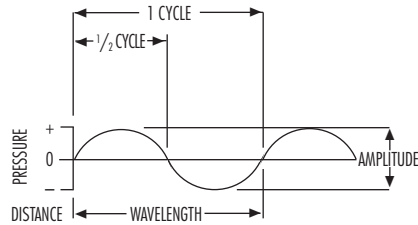

Schematic of sound wave

One cycle is a change from high pressure to low pressure and back to high pressure. The number of cycles per second is called Hertz, abbreviated "Hz." So, a 1,000 Hz tone has 1,000 cycles per second.

The wavelength of a sound is the physical distance from the start of one cycle to the start of the next cycle. Wavelength is related to frequency by the speed of sound. The speed of sound in air is about 1130 feet per second or 344 meters/second. The speed of sound is constant no matter what the frequency. The wavelength of a sound wave of any frequency can be determined by these relationships:

The Wave Equation: $c = f \cdot l$
 speed of sound = frequency • wavelength
 or

$$\text{wavelength} = \frac{\text{speed of sound}}{\text{frequency}}$$
 for a 500Hz sound wave:

$$\text{wavelength} = \frac{1,130 \text{ feet per second}}{500\text{Hz}}$$

$$\text{wavelength} = 2.26 \text{ feet}$$

Approximate wavelengths of common frequencies:
 100 Hz: about 10 feet
 1000 Hz: about 1 foot
 10,000 Hz: about 1 inch

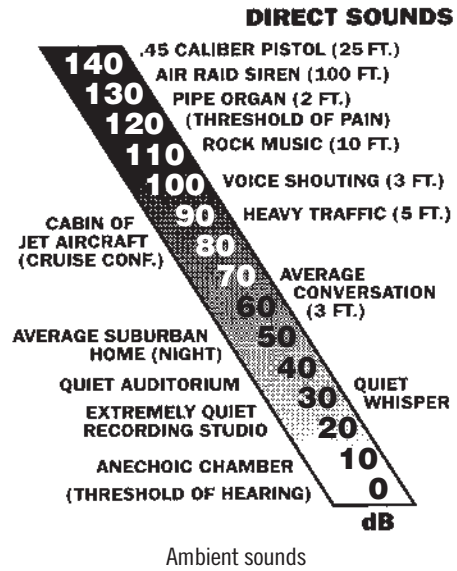

Loudness

The fluctuation of air pressure created by sound is a change above and below normal atmospheric pressure. This is what the human ear responds to. The varying amount of pressure of the air molecules compressing and expanding is related to the apparent loudness at the human ear. The greater the pressure change, the louder the sound. Under ideal conditions the human ear can sense a pressure change as small as 0.0002 microbars (1 microbar = 1/1,000,000 atmospheric pressure). The threshold of pain is about 200 microbars, one million times greater! Obviously the human ear responds to a wide range of amplitude of sound. This amplitude range is more commonly measured in decibels Sound Pressure Level (dB SPL), relative to 0.0002 microbars (0 dB SPL). 0 dB SPL is the threshold of hearing L_p and 120 dB SPL is the threshold of pain. 1dB is about the smallest change in SPL that can be heard. A 3dB change is generally noticeable while a 6dB change is very noticeable. A 10dB SPL increase is perceived to be twice as loud!

Sound Propagation

There are four basic ways in which sound can be altered by its environment as it travels or propagates: reflection, absorption, diffraction and refraction.

1. Reflection - A sound wave can be reflected by a surface or other object if the object is physically as large or larger than the wavelength of the sound. Because low frequency sounds have long wavelengths they can only be reflected by large objects. Higher frequencies can be reflected by smaller objects and surfaces as well as large. The reflected sound will have a different frequency characteristic than the direct sound if all frequencies are not reflected equally.

Reflection is also the source of echo, reverb, and standing waves:

Echo occurs when a reflected sound is delayed long enough (by a distant reflective surface) to be heard by the listener as a distinct repetition of the direct sound.

Reverberation consists of many reflections of a sound, maintaining the sound in a reflective space for a time even after the direct sound has stopped.

Standing waves in a room occur for certain frequencies related to the distance between parallel walls. The original sound and the reflected sound will begin to reinforce each other when the distance between two opposite walls is equal to a multiple of half the wavelength of the sound. This happens primarily at low frequencies due to their longer wavelengths and relatively high energy.

2. Absorption - Some materials absorb sound rather than reflect it. Again, the efficiency of absorption is dependent on the wavelength. Thin absorbers like carpet and acoustic ceiling tiles can affect high frequencies only, while thick absorbers such as drapes, padded furniture and specially designed *bass traps* are required to attenuate low frequencies. Reverberation in a room can be controlled by adding absorption: the more absorption the less reverberation. Clothed humans absorb mid and high frequencies well, so the presence or absence of an audience has a significant effect on the sound in an otherwise reverberant venue.

3. Diffraction - A sound wave will typically bend around obstacles in its path which are smaller than its wavelength. Because a low frequency sound wave is much longer than a high frequency wave, low frequencies will bend around objects that high frequencies cannot. The effect is that high frequencies tend to have a higher directivity and are more easily blocked while low frequencies are essentially omnidirectional. In sound reinforcement, it is difficult to get good directional control at low frequencies for both microphones and loudspeakers.

4. Refraction - The bending of a sound wave as it passes through some change in the density of the environment. This effect is primarily noticeable outdoors at large distances from loudspeakers due to atmospheric effects such as wind or temperature gradients. The sound will appear to bend in a certain direction due to these effects.

Direct vs. Ambient Sound

A very important property of direct sound is that it becomes weaker as it travels away from the sound source. The amount of change is controlled by the **inverse-square law** which states that the level change is inversely proportional to the square of the distance change. When the distance from a sound source doubles, the sound level decreases by 6dB. This is a noticeable decrease. For example, if the sound from a guitar amplifier is 100 dB SPL at 1 ft. from the cabinet it will be 94 dB at 2 ft., 88 dB at 4 ft., 82 dB at 8 ft., etc. Conversely, when the distance is cut in half the sound level increases by 6dB: It will be 106 dB at 6 inches and 112 dB at 3 inches!

On the other hand, the ambient sound in a room is at nearly the same level throughout the room. This is because the ambient sound has been reflected many times within the room until it is essentially non-directional. Reverberation is an example of non-directional sound.

For this reason the ambient sound of the room will become increasingly apparent as a microphone is placed further away from the direct sound source. In every room, there is a distance (measured from the sound source) where the direct sound and the reflected (or reverberant) sound become equal in intensity. In acoustics, this is known as the **Critical Distance**. If a microphone is placed at the Critical Distance or farther, the sound quality picked up may be very poor. This sound is often described as “echoey”, reverberant, or “bottom of the barrel”. The reflected sound overlaps and blurs the direct sound.

Critical distance may be estimated by listening to a sound source at a very short distance, then moving away until the sound level no longer decreases but seems to be constant. That distance is critical distance.

Microphone Techniques for LIVE SOUND

A unidirectional microphone should be positioned no farther than 50% of the Critical Distance, e.g. if the Critical Distance is 10 feet, a unidirectional mic may be placed up to 5 feet from the sound source. Highly reverberant rooms may require very close microphone placement. The amount of direct sound relative to ambient sound is controlled primarily by the distance of the microphone to the sound source and to a lesser degree by the directional pattern of the mic.

Phase relationships and interference effects

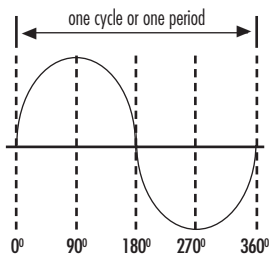

Sound pressure wave

The phase of a single frequency sound wave is always described relative to the starting point of the wave or 0 degrees. The pressure change is also zero at this point. The peak of the high pressure zone is at 90 degrees, the pressure change falls to

zero again at 180 degrees, the peak of the low pressure zone is at 270 degrees, and the pressure change rises to zero at 360 degrees for the start of the next cycle.

Two identical sound waves starting at the same point in time are called "in-phase" and will sum together creating a single wave with double the amplitude but otherwise identical to the original waves. Two identical sound waves with one wave's starting point occurring at the 180 degree point of the other wave are said to be "out of phase" and the two waves will cancel each other completely. When two sound waves of the same single frequency but different starting points are combined the resulting wave is said to have "phase shift" or an apparent starting point somewhere between the original starting points. This new wave will have the same frequency as the original waves but will have increased or decreased amplitude depending on the degree of phase difference. Phase shift, in this case, indicates that the 0 degree points of two identical waves are not the same.

Most soundwaves are not a single frequency but are made up of many frequencies. When identical multiple-frequency soundwaves combine there are three possibilities for the resulting wave: a doubling of amplitude at all frequencies if the waves are in phase, a complete cancellation at all frequencies if the waves are 180 degrees out of phase, or partial cancellation and partial reinforcement at various frequencies if the waves have intermediate phase relationship. The results may be heard as *interference effects*.

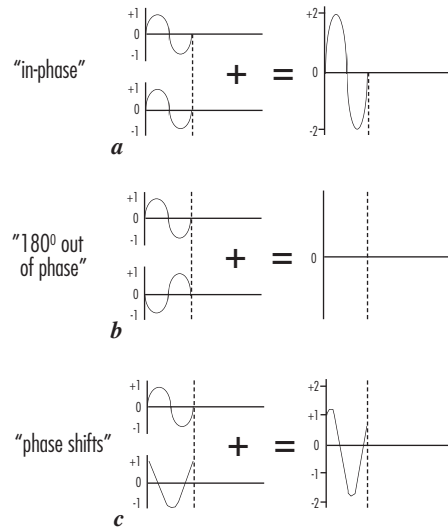

Phase relationships

The first case is the basis for the increased sensitivity of *boundary* or surface-mount microphones. When a microphone element is placed very close to an acoustically reflective surface both the incident and reflected sound waves are *in phase* at the microphone. This results in a 6dB increase (doubling) in sensitivity, compared to the same microphone in *free space*. This occurs for reflected frequencies whose wavelength is greater than the distance from the microphone to the surface: if the distance is less than one-quarter inch this will be the case for frequencies up to at least 18 kHz. However, this 6dB increase will not occur for frequencies that are not reflected, that is, frequencies that are either absorbed by the surface or that diffract around the surface. High frequencies may be absorbed by surface materials such as carpeting or other acoustic treatments. Low frequencies will diffract around the surface if their wavelength is much greater than the dimensions of the surface: the boundary must be at least 5 ft. square to reflect frequencies down to 100 Hz.

The second case occurs when two closely spaced microphones are wired *out of phase*, that is, with reverse polarity. This usually only happens by accident, due to miswired microphones or cables but the effect is also used as the basis for certain *noise-canceling* microphones. In this technique, two identical microphones are placed very close to each other (sometimes within the same housing) and wired with opposite polarity. Sound waves from distant sources which arrive equally at the two microphones are effectively canceled when the outputs are mixed.

Microphone Techniques for LIVE SOUND

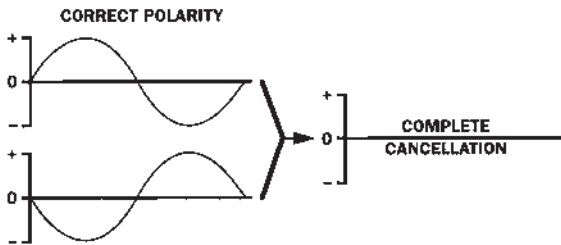
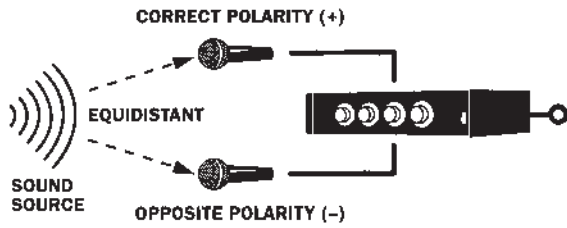

Polarity reversal

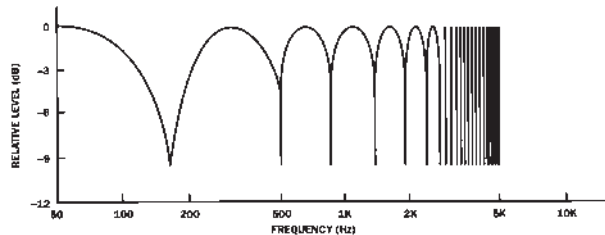
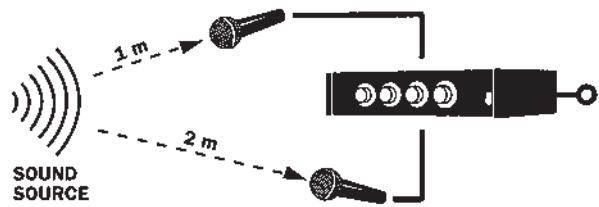

Multi-mic comb filtering

However, sound from a source which is much closer to one element than to other will be heard. Such *close-talk* microphones, which must literally have the lips of the talker touching the grille, are used in high-noise environments such as aircraft and industrial paging but rarely with musical instruments due to their limited frequency response.

It is the last case which is most likely in musical sound reinforcement, and the audible result is a degraded frequency response called "comb filtering." The pattern of peaks and dips resembles the teeth of a comb and the depth and location of these notches depend on the degree of phase shift.

With microphones this effect can occur in two ways. The first is when two (or more) mics pick up the same sound source at different distances. Because it takes longer for the sound to arrive at the more distant microphone there is effectively a phase difference between the signals from the mics when they are combined (electrically) in the mixer. The resulting comb filtering depends on the sound arrival time difference between the microphones: a large time difference (long distance) causes comb filtering to begin at low frequencies, while a small time difference (short distance) moves the comb filtering to higher frequencies.

The second way for this effect to occur is when a single microphone picks up a direct sound and also a delayed version of the same sound. The delay may be due to an acoustic reflection of the original sound or to multiple sources of the original sound. A guitar cabinet with more

than one speaker or multiple loudspeaker cabinets for a single instrument would be examples. The delayed sound travels a longer distance (longer time) to the mic and thus has a phase difference relative to the direct sound. When these sounds combine (acoustically) at the microphone, comb filtering results. This time the effect of the comb filtering depends on the distance between the microphone and the source of the reflection or the distance between the multiple sources.

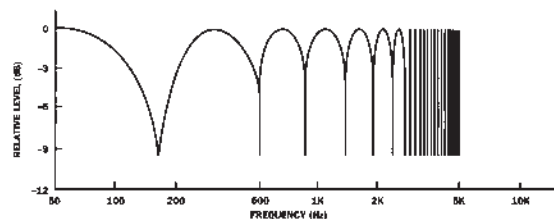
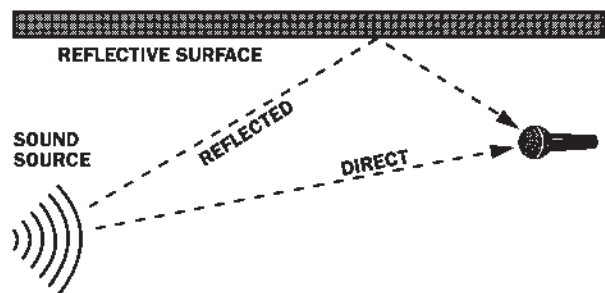

Reflection comb filtering

Microphone Techniques for **LIVE SOUND**

The 3-to-1 Rule

When it is necessary to use multiple microphones or to use microphones near reflective surfaces the resulting interference effects may be minimized by using the 3-to-1 rule. For multiple microphones the rule states that the distance between microphones should be at least three times the distance from each microphone to its intended sound source. The sound picked up by the more distant microphone is then at least 12dB less than the sound picked up by the closer one. This insures that the audible effects of comb filtering are reduced by at least that much. For reflective surfaces, the microphone should be at least 1½ times as far from that surface as it is from its intended sound source. Again, this insures minimum audibility of interference effects.

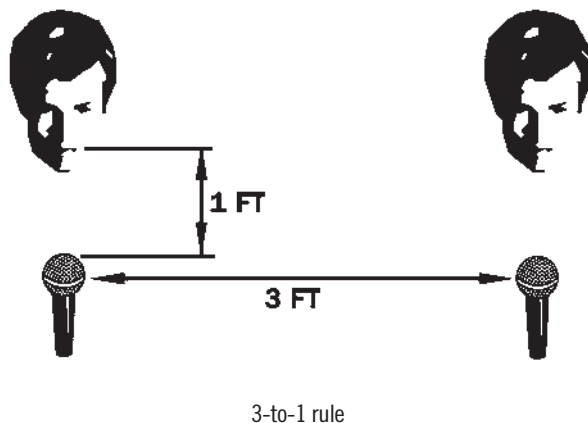

Strictly speaking, the 3-to-1 rule is based on the behavior of omnidirectional microphones. It can be relaxed slightly if unidirectional microphones are used and they are aimed appropriately, but should still be regarded as a basic rule of thumb for worst case situations.

Microphone Phase Effects

One effect often heard in sound reinforcement occurs when two microphones are placed in close proximity to the same sound source, such as a drum kit or instrument amplifier. Many times this is due to the phase relationship of the sounds arriving at the microphones. If two microphones are picking up the same sound source from different locations, some phase cancellation or summing may be occurring. Phase cancellation happens when two microphones are receiving the same soundwave but with opposite pressure zones (that is, 180 degrees out of phase). This is usually not desired. A mic with a different polar pattern may reduce the pickup of unwanted sound and reduce the effect or physical isolation can be used. With a drum kit, physical isolation of the individual drums is not possible. In this situation the choice of microphones may be more dependent on the off-axis rejection characteristic of the mic.

Another possibility is phase reversal. If there is cancellation occurring, a 180 degree phase flip will create phase summing of the same frequencies. A common approach to the snare drum is to place one mic on the top head and one on the bottom head. Because the mics are picking up relatively similar sound sources at different points in the sound wave, you may experience some phase cancellations. Inverting the phase of one mic will sum any frequencies being canceled. This may sometimes achieve a “fatter” snare drum sound. This effect will change dependent on mic locations. The phase inversion can be done with an in-line phase reverse adapter or by a phase invert switch found on many mixers inputs.

Potential Acoustic Gain vs. Needed Acoustic Gain

The basic purpose of a sound reinforcement system is to deliver sufficient sound level to the audience so that they can hear and enjoy the performance throughout the listening area. As mentioned earlier, the amount of reinforcement needed depends on the loudness of the instruments or performers themselves and the size and acoustic nature of the venue. This Needed Acoustic Gain (NAG) is the amplification factor necessary so that the furthest listeners can hear as if they were close enough to hear the performers directly.

To calculate NAG: **$NAG = 20 \times \log (D_f/D_n)$**

Where: D_f = distance from sound source to furthest listener

D_n = distance from sound source to nearest listener

log = logarithm to base 10

Note: the sound source may be a musical instrument, a vocalist or perhaps a loudspeaker.

The equation for NAG is based on the inverse-square law, which says that the sound level decreases by 6dB each time the distance to the source doubles. For example, the sound level (without a sound system) at the first row of the audience (10 feet from the stage) might be a comfortable 85dB. At the last row of the audience (80 feet from the stage) the level will be 18dB less or 67dB. In this case the sound system needs to provide 18dB of gain so that the last row can hear at the same level as the first row. The limitation in real-world sound systems is not how loud the system can get with a recorded sound source but rather how loud it can get with a microphone as its input. The maximum loudness is ultimately limited by acoustic feedback.

The amount of gain-before-feedback that a sound reinforcement system can provide may be estimated mathematically. This Potential Acoustic Gain involves the distances between sound system components, the number of open mics, and other variables. The system will be sufficient if the calculated Potential Acoustic Gain (PAG) is equal to or greater than the Needed Acoustic Gain (NAG). Below is an illustration showing the key distances.

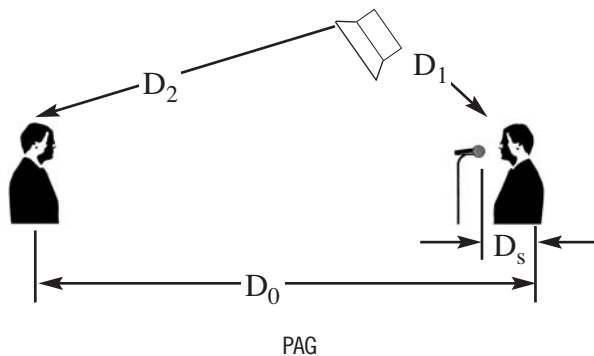

The simplified PAG equation is:

$$PAG = 20 (\log D_1 - \log D_2 + \log D_0 - \log D_s) - 10 \log NOM - 6$$

Where: PAG = Potential Acoustic Gain (in dB)

D_s = distance from sound source to microphone

D_0 = distance from sound source to listener

D_1 = distance from microphone to loudspeaker

D_2 = distance from loudspeaker to listener

NOM = the number of open microphones

-6 = a 6 dB feedback stability margin

log = logarithm to base 10

In order to make PAG as large as possible, that is, to provide the maximum gain-before-feedback, the following rules should be observed:

- 1) Place the microphone as close to the sound source as practical.
- 2) Keep the microphone as far away from the loudspeaker as practical.
- 3) Place the loudspeaker as close to the audience as practical.
- 4) Keep the number of microphones to a minimum.

In particular, the logarithmic relationship means that to make a 6dB change in the value of PAG the corresponding distance must be doubled or halved. For example, if a microphone is 1 ft. from an instrument, moving it to 2 ft. away will decrease the gain-before-feedback by 6dB while moving it to 4 ft. away will decrease it by 12dB. On the other hand, moving it to 6 in. away increases gain-before-feedback by 6dB while moving it to only 3 in. away will increase it by 12dB. This is why the single most significant factor in maximizing gain-before-feedback is to place the microphone as close as practical to the sound source.

Microphone Techniques

for LIVE SOUND

The NOM term in the PAG equation reflects the fact that gain-before-feedback decreases by 3dB every time the number of open (active) microphones doubles. For example, if a system has a PAG of 20dB with a single microphone, adding a second microphone will decrease PAG to 17dB and adding a third and fourth mic will decrease PAG to 14dB. This is why the number of microphones should be kept to a minimum and why unused microphones should be turned off or attenuated. Essentially, the gain-before-feedback of a sound system can be evaluated strictly on the relative location of sources, microphones, loudspeakers, and audience, as well as the number of microphones, but without regard to the actual type of component. Though quite simple, the results are very useful as a best case estimate.

Understanding principles of basic acoustics can help to create an awareness of potential influences on reinforced sound and to provide some insight into controlling them. When effects of this sort are encountered and are undesirable, it may be possible to adjust the sound source, use a microphone with a different directional characteristic, reposition the microphone or use fewer microphones, or possibly use acoustic treatment to improve the situation. Keep in mind that in most cases, acoustic problems can best be solved acoustically, not strictly by electronic devices.

General Rules

Microphone technique is largely a matter of personal taste—whatever method sounds right for the particular instrument, musician, and song is right. There is no one ideal microphone to use on any particular instrument. There is also no one ideal way to place a microphone. Choose and place the microphone to get the sound you want. We recommend experimenting with a variety of microphones and positions until you create your desired sound. However, the desired sound can often be achieved more quickly and consistently by understanding basic microphone characteristics, sound-radiation properties of musical instruments, and acoustic fundamentals as presented above.

Here are some suggestions to follow when miking musical instruments for sound reinforcement.

- Try to get the sound source (instrument, voice, or amplifier) to sound good acoustically (“live”) before miking it.
- Use a microphone with a frequency response that is limited to the frequency range of the instrument, if possible, or filter out frequencies below the lowest fundamental frequency of the instrument.
- To determine a good starting microphone position, try closing one ear with your finger. Listen to the sound source with the other ear and move around until you find a spot that sounds good. Put the microphone there. However, this may not be practical (or healthy) for extremely close placement near loud sources.
- The closer a microphone is to a sound source, the louder the sound source is compared to reverberation and ambient noise. Also, the **Potential Acoustic Gain** is increased—that is, the system can produce more level before feedback occurs. Each time the distance between the microphone and sound source is halved, the sound pressure level at the microphone (and hence the system) will increase by 6 dB. (**Inverse Square Law**)
- Place the microphone only as close as necessary. Too close a placement can color the sound source’s tone quality (timbre), by picking up only one part of the instrument. Be aware of **Proximity Effect** with unidirectional microphones and use bass rolloff if necessary.
- Use as few microphones as are necessary to get a good sound. To do that, you can often pick up two or more sound sources with one microphone. Remember: every time the number of microphones doubles, the **Potential Acoustic Gain** of the sound system decreases by 3 dB. This means that the volume level of the system must be turned down for every extra mic added in order to prevent feedback. In addition, the amount of noise picked up increases as does the likelihood of interference effects such as comb-filtering.

Microphone Techniques for **LIVE SOUND**

- When multiple microphones are used, the distance between microphones should be at least three times the distance from each microphone to its intended sound source. This will help eliminate phase cancellation. For example, if two microphones are each placed one foot from their sound sources, the distance between the microphones should be at least three feet. **(3 to 1 Rule)**
- To reduce feedback and pickup of unwanted sounds:
 - 1) place microphone as close as practical to desired sound source
 - 2) place microphone as far as practical from unwanted sound sources such as loudspeakers and other instruments
 - 3) aim unidirectional microphone toward desired sound source (on-axis)
 - 4) aim unidirectional microphone away from undesired sound source (180 degrees off-axis for cardioid, 126 degrees off-axis for supercardioid)
 - 5) use minimum number of microphones
- To reduce handling noise and stand thumps:
 - 1) use an accessory shock mount (such as the Shure A55M)
 - 2) use an omnidirectional microphone
 - 3) use a unidirectional microphone with a specially designed internal shock mount
- To reduce “pop” (explosive breath sounds occurring with the letters “p,” “b,” and “t”):
 - 1) mic either closer or farther than 3 inches from the mouth (because the 3-inch distance is worst)
 - 2) place the microphone out of the path of pop travel (to the side, above, or below the mouth)
 - 3) use an omnidirectional microphone
 - 4) use a microphone with a pop filter. This pop filter can be a ball-type grille or an external foam windscreen
- If the sound from your loudspeakers is distorted the microphone signal may be overloading your mixer’s input. To correct this situation, use an in-line attenuator (such as the Shure A15AS), or use the input attenuator on your mixer to reduce the signal level from the microphone.

Seasoned sound engineers have developed favorite microphone techniques through years of experience. If you lack this experience, the suggestions listed on the following pages should help you find a good starting point. These suggestions are not the only possibilities; other microphones and positions may work as well or better for your intended application. Remember—Experiment and Listen!



Microphone Techniques for **LIVE SOUND**

Microphone Placement	Tonal Balance	Comments
Lead vocal:		
Handheld or on stand, microphone windscreen touching lips or just a few inches away	Bassy, robust (unless an omni is used)	Minimizes feedback and leakage. Roll off bass if desired for more natural sound.
Backup vocals:		
One microphone per singer Handheld near chin or stand-mounted Touching lips or a few inches away	Bassy, robust (unless an omni is used)	Minimizes feedback and leakage. Allows engineer control of voice balances. Roll off bass if necessary for more natural sound when using cardioids.
Choral groups:		
1 to 3 feet above and 2 to 4 feet in front of the first row of the choir, aimed toward the middle row(s) of the choir, approximately 1 microphone per 15-20 people	Full range, good blend, semi-distant	Use flat-response unidirectional microphones, Use minimum number of microphones needed to avoid overlapping pickup areas.
Miniature microphone clipped outside of sound hole	Natural, well-balanced	Good isolation. Allows freedom of movement.
Miniature microphone clipped inside sound hole	Bassy, less string noise	Reduces feedback.
Acoustic guitar:		
8 inches from sound hole	Bassy	Good starting placement when leakage or feedback is a problem. Roll off bass for a more natural sound (more for a uni than an omni).
3 inches from sound hole	Very bassy, boomy, muddy, full	Very good isolation. Bass rolloff needed for a natural sound.
4 to 8 inches from bridge	Woody, warm, mellow. Midbassy, lacks detail	Reduces pick and string noise.
6 inches above the side, over the bridge, and even with the front soundboard	Natural, well-balanced, slightly bright	Less pickup of ambience and leakage than 3 feet from sound hole.
miniature microphone clipped outside of sound hole	Natural, well-balanced	Good isolation. Allows freedom of movement.
miniature microphone clipped inside sound hole	Bassy, less string noise	Reduces feedback.

Microphone Placement	Tonal Balance	Comments
Banjo:		
3 inches from center of head	Bassy, thumpy	Rejects feedback and leakage. Roll off bass for natural sound.
3 inches from edge of head	Bright	Rejects feedback and leakage.
Miniature microphone clipped to tailpiece aiming at bridge	Natural	Rejects feedback and leakage. Allows freedom of movement.
Violin (fiddle):		
A few inches from side	Natural	Well-balanced sound.
Miniature lavalier microphone mounted on strings between bridge and tailpiece	Full, bright	Use string mount. Listen for vibrations, adjust mount position.
Cello:		
1 foot from bridge	Well-defined	Well-balanced sound, but little isolation.
General string instruments (mandolin, dobro and dulcimer):		
Miniature microphone attached to strings between bridge and tailpiece	Bright	Minimizes feedback and leakage. Allows freedom of movement.
Acoustic bass (upright bass, string bass, bass violin):		
6 inches to 1 foot out front, just above bridge	Well-defined	Natural sound.
A few inches from f-hole	Full	Roll off bass if sound is too boomy.
Wrap microphone in foam padding (except for grille) and put behind bridge or between tailpiece and body	Full, "tight"	Minimizes feedback and leakage.
Miniature lavalier microphone mounted on strings between bridge and tailpiece	Full, bright	Use string mount. Listen for vibrations, adjust mount position.
Harp:		
Aiming toward player at part of soundboard, about 2 feet away	Natural	See "Stereo Microphone Techniques" section for other possibilities.
Tape miniature microphone to soundboard	Somewhat constricted	Minimizes feedback and leakage.



Microphone Techniques for **LIVE SOUND**

Microphone Placement	Tonal Balance	Comments
Grand piano:		
12 inches above middle strings, 8 inches horizontally from hammers with lid off or at full stick	Natural, well-balanced	Less pickup of ambience and leakage. Move microphone(s) farther from hammers to reduce attack and mechanical noises. Good coincident-stereo placement. See “Stereo Microphone Techniques” section.
8 inches above treble strings, as above	Natural, well-balanced, slightly bright	Place one microphone over bass strings and one over treble strings for stereo. Phase cancellations may occur if the recording is heard in mono.
Aiming into sound holes	Thin, dull, hard, constricted	Very good isolation. Sometimes sounds good for rock music. Boost mid-bass and treble for more natural sound.
		
6 inches over middle strings, 8 inches from hammers, with lid on short stick	Muddy, boomy, dull, lacks attack	Improves isolation. Bass rolloff and some treble boost required for more natural sound.
Next to the underside of raised lid, centered on lid	Bassy, full	Unobtrusive placement.
Underneath the piano, aiming up at the soundboard	Bassy, dull, full	Unobtrusive placement.
Surface-mount microphone mounted on underside of lid over lower treble strings, horizontally close to hammers for brighter sound, further from hammers for more mellow sound	Bright, well- balanced	Excellent isolation. Experiment with lid height and microphone placement on piano lid for desired sounds.
Two surface-mount microphones positioned on the closed lid, under the edge at its keyboard edge, approximately 2/3 of the distance from middle A to each end of the keyboard	Bright, well-balanced, strong attack	Excellent isolation. Moving “low” mic away from keyboard six inches provides truer reproduction of the bass strings while reducing damper noise. By splaying these two mics outward slightly, the overlap in the middle registers can be minimized.
Surface-mount microphone placed vertically on the inside of the frame, or rim, of the piano, at or near the apex of the piano’s curved wall	Full, natural	Excellent isolation. Minimizes hammer and damper noise. Best if used in conjunction with two surface-mount microphones mounted to closed lid, as above.
		

Microphone Placement	Tonal Balance	Comments
----------------------	---------------	----------

Upright piano:

Just over open top, above treble strings	Natural (but lacks deep bass), picks up hammer attack	Good placement when only one microphone is used.
Just over open top, above bass strings	Slightly full or tubby, picks up hammer attack	Mike bass and treble strings for stereo.
Inside top near the bass and treble strings	Natural, picks up hammer attack	Minimizes feedback and leakage. Use two microphones for stereo.
8 inches from bass side of soundboard	Full, slightly tubby, no hammer attack	Use this placement with the following placement for stereo.
8 inches from treble side of soundboard	Thin, constricted, no hammer attack	Use this placement with the preceding placement for stereo.
1 foot from center of soundboard on hard floor or one-foot-square plate on carpeted floor, aiming at piano. Soundboard should face into room	Natural, good presence	Minimize pickup of floor vibrations by mounting microphone in low-profile shock-mounted microphone stand.
Aiming at hammers from front, several inches away (remove front panel)	Bright, picks up hammer attack	Mike bass and treble strings for stereo.

Brass (trumpet, cornet, trombone, tuba):

The sound from these instruments is very directional. Placing the mic off axis with the bell of the instrument will result in less pickup of high frequencies.

1 to 2 feet from bell. A couple of instruments can play into one microphone	On-axis to bell sounds bright; to one side sounds natural or mellow	Close miking sounds "tight" and minimizes feedback and leakage. More distant placement gives fuller, more dramatic sound.
Miniature microphone mounted on bell	Bright	Maximum isolation.

Microphone Techniques for **LIVE SOUND**

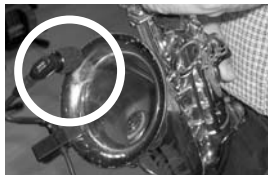
Microphone Placement	Tonal Balance	Comments
French horn:		
Microphone aiming toward bell	Natural	Watch out for extreme fluctuations on VU meter.
Saxophone:		
<p>With the saxophone, the sound is fairly well distributed between the finger holes and the bell. Miking close to the finger holes will result in key noise. The soprano sax must be considered separately because its bell does not curve upward. This means that, unlike all other saxophones, placing a microphone toward the middle of the instrument will not pick-up the sound from the key holes and the bell simultaneously. The saxophone has sound characteristics similar to the human voice. Thus, a shaped response microphone designed for voice works well.</p>		
A few inches from and aiming into bell	Bright	Minimizes feedback and leakage.
A few inches from sound holes	Warm, full	Picks up fingering noise.
A few inches above bell and aiming at sound holes	Natural	Good recording technique.
		
Miniature microphone mounted on bell	Bright, punchy	Maximum isolation, up-front sound.
		
Flute:		
<p>The sound energy from a flute is projected both by the embouchure and by the first open fingerhole. For good pickup, place the mic as close as possible to the instrument. However, if the mic is too close to the mouth, breath noise will be apparent. Use a windscreen on the mic to overcome this difficulty.</p>		
A few inches from area between mouthpiece and first set of finger holes	Natural, breathy	Pop filter or windscreen may be required on microphone.
A few inches behind player's head, aiming at finger holes	Natural	Reduces breath noise.
Woodwinds (Oboe, bassoon, etc):		
About 1 foot from sound holes	Natural	Provides well-balanced sound.
A few inches from bell	Bright	Minimizes feedback and leakage.

Microphone Placement	Tonal Balance	Comments
----------------------	---------------	----------

Harmonica:

Very close to instrument	Full, bright	Minimizes feedback and leakage. Microphone may be cupped in hands.
--------------------------	--------------	---

Accordion:

Miniature microphone mounted internally	Emphasized midrange	Minimizes feedback and leakage. Allows freedom of movement.
---	---------------------	--

Electric guitar amplifier/speaker:

The electric guitar has sound characteristics similar to the human voice. Thus, a shaped response microphone designed for voice works well.

4 inches from grille cloth at center of speaker cone	Natural, well-balanced	Small microphone desk stand may be used if loudspeaker is close to floor.
--	------------------------	---

1 inch from grille cloth at center of speaker cone



Bassy	Minimizes feedback and leakage.
-------	---------------------------------

Off-center with respect to speaker cone	Dull or mellow	Microphone closer to edge of speaker cone results in duller sound. Reduces amplifier hiss noise.
---	----------------	--

3 feet from center of speaker cone	Thin, reduced bass	Picks up more room ambience and leakage.
------------------------------------	--------------------	--

Miniature microphone draped over amp in front of speaker	Emphasized midrange	Easy setup, minimizes leakage.
--	---------------------	--------------------------------

Microphone placed behind open back cabinet	Depends on position	Can be combined with mic in front of cabinet, but be careful of phase cancellation.
--	---------------------	---

Bass guitar amplifier/speaker:

Mike speaker as described in Electric Guitar Amplifier section	Depends on placement	Improve clarity by cutting frequencies around 250 Hz and boosting around 1,500 Hz.
--	----------------------	--

Electric keyboard amplifier/speakers:

Mike speaker as described in Electric Guitar Amplifier section	Depends on brand of piano	Roll off bass for clarity, roll off highs to reduce hiss.
--	---------------------------	---

Microphone Techniques for **LIVE SOUND**

Microphone Placement	Tonal Balance	Comments
Leslie organ speaker:		
Aim one microphone into top louvers 3 inches to 1 foot away	Natural, lacks deep bass	Good one-mike pickup.
Mike top louvers and bottom bass speaker 3 inches to 1 foot away	Natural, well-balanced	Excellent overall sound.
Mike top louvers with two microphones, one close to each side. Pan to left and right. Mike bottom bass speaker 3 inches to 1 foot away and pan its signal to center	Natural, well-balanced	Stereo effect.

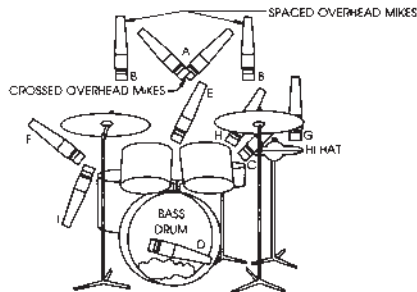

Front View

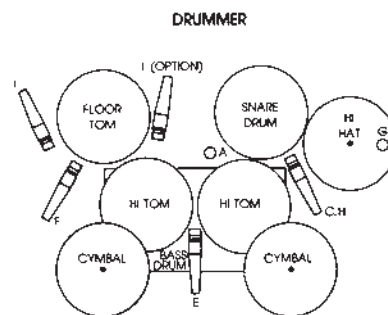

Top View

Drum kit:





In most sound reinforcement systems, the drum set is miked with each drum having its own mic. Using microphones with tight polar patterns on toms helps to isolate the sound from each drum. It is possible to share one mic with two toms, but then, a microphone with a wider polar pattern should be used. The snare requires a mic that can handle very high SPL, so a dynamic mic is usually chosen. To avoid picking up the hi-hat in the snare mic, aim the null of the snare mic towards the hi-hat. The brilliance and high frequencies of cymbals are picked up best by a flat response condenser mic.

1. Overhead-Cymbals:

One microphone over center of drum set, about 1 foot above drummer's head (Position A); or use two spaced or crossed microphones for stereo (Positions A or B). See "Stereo Microphone Techniques" section

Natural; sounds like drummer hears set

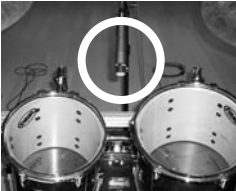
Picks up ambience and leakage. For cymbal pickup only, roll off low frequencies. Boost at 10,000 Hz for added sizzle. To reduce excessive cymbal ringing, apply masking tape in radial strips from bell to rim.

Microphone Placement	Tonal Balance	Comments
<p>2. Snare drum:</p> <p>Just above top head at edge of drum, aiming at top head. Coming in from front of set on boom (Position C); or miniature microphone mounted directly on drum</p>		<p>Full, smooth</p> <p>Tape gauze pad or handkerchief on top head to tighten sound. Boost at 5,000 Hz for attack, if necessary.</p>
<p>3. Bass drum (kick drum):</p> <p>Placing a pad of paper towels where the beater hits the drum will lessen boominess. If you get rattling or buzzing problems with the drum, put masking tape across the drum head to damp out these nuisances. Placing the mic off center will pick up more overtones.</p> <p>Remove front head if necessary. Mount microphone on boom arm inside drum a few inches from beater head, about 1/3 of way in from edge of head (Position D); or place surface-mount microphone inside drum, on damping material, with microphone element facing beater head</p>		<p>Full, good impact</p> <p>Put pillow or blanket on bottom of drum against beater head to tighten beat. Use wooden beater, or loosen head, or boost around 2,500 Hz for more impact and punch.</p>
<p>4. Tom-toms:</p> <p>One microphone between every two tom-toms, close to top heads (Position E); or one microphone just above each tom-tom rim, aiming at top head (Position F); or one microphone inside each tom-tom with bottom head removed; or miniature microphone mounted directly on drum</p>		<p>Full, good impact</p> <p>Inside drum gives best isolation. Boost at 5,000 Hz for attack, if necessary.</p>
<p>5. Hi-hat:</p> <p>Aim microphone down towards the cymbals, a few inches over edge away from drummer (Position G). Or angle snare drum microphone slightly toward hi-hat to pick up both snare and hi-hat</p>		<p>Natural, bright</p> <p>Place microphone or adjust cymbal height so that puff of air from closing hi-hat cymbals misses mike. Roll off bass to reduce low-frequency leakage. To reduce hi-hat leakage into snare-drum microphone, use small cymbals vertically spaced 1/2" apart.</p>

Microphone Techniques for **LIVE SOUND**

Microphone Placement	Tonal Balance	Comments
----------------------	---------------	----------

6. Snare, hi-hat and high tom:

Place single microphone a few inches from snare drum edge, next to high tom, just above top head of tom. Microphone comes in from front of the set on a boom (Position H)	Natural	In combination with Placements 3 and 7, provides good pickup with minimum number of microphones. Tight sound with little leakage.
---	---------	---

7. Cymbals, floor tom and high tom:

Using single microphone, place its grille just above floor tom, aiming up toward cymbals and one of high tomes (Position I)	Natural	In combination with Placements 3 and 6, provides good pickup with minimum number of microphones. Tight sound with little leakage.
---	---------	---

One microphone: Use Placement 1. Placement 6 may work if the drummer limits playing to one side of the drum set.

Two microphones: Placements 1 and 3; or 3 and 6.

Three microphones: Placements 1, 2, and 3; or 3, 6, and 7.

Four microphones: Placements 1, 2, 3, and 4.

Five microphones: Placements 1, 2, 3, 4, and 5.

More microphones: Increase number of tom-tom microphones as needed.
Use a small microphone mixer to submix multiple drum microphones into one channel.

Timbales, congas, bongos:

One microphone aiming down between pair of drums, just above top heads	Natural	Provides full sound with good attack.
--	---------	---------------------------------------

Tambourine:

One microphone placed 6 to 12 inches from instrument	Natural	Experiment with distance and angles if sound is too bright.
--	---------	---

Microphone Placement	Tonal Balance	Comments
----------------------	---------------	----------

Steel Drums:

Tenor, Second Pan, Guitar

One microphone placed 4 inches above each pan

Bright, with plenty of attack

Allow clearance for movement of pan.

Microphone placed underneath pan

Decent if used for tenor or second pans. Too boomy with lower voiced pans.

Cello, Bass

One microphone placed 4 - 6 inches above each pan

Natural

Can double up pans to a single microphone.

Xylophone, marimba, vibraphone:

Two microphones aiming down toward instrument, about 1 1/2 feet above it, spaced 2 feet apart, or angled 135° apart with grilles touching

Natural

Pan two microphones to left and right for stereo. See "Stereo Microphone Techniques" section.

Glockenspiel:

One microphone placed 4 - 6 inches above bars

Bright, with lots of attack

For less attack, use rubber mallets instead of metal mallets. Plastic mallets will give a medium attack.

Stage area miking	Tonal Balance	Comments
-------------------	---------------	----------

Downstage:

Surface-mount microphones along front of stage aimed upstage, one microphone center stage; use stage left and stage right mics as needed, approximately 1 per 10-15 feet

Voice range, semi-distant

Use flat response, unidirectional microphones. Use minimum number of microphones needed to avoid overlapping pickup area. Use shock mount if needed.

Upstage:

Microphones suspended 8 -10 feet above stage aimed upstage, one microphone center stage; use stage left and stage right mics as needed, approximately 1 per 10-15 feet

Voice range, semi-distant

Use flat response, unidirectional microphones. Use minimum number of microphones needed to avoid overlapping pickup area.

Spot pickup:

Use wireless microphones on principal actors; mics concealed in set; "shotgun" microphones from above or below

Voice range, on mic

Multiple wireless systems must utilize different frequencies. Use lavalier or handheld microphones as appropriate.

Microphone Techniques for **LIVE SOUND**

Stereo Microphone Techniques

These methods are recommended for pickup of orchestras, bands, choirs, pipe organs, quartets, soloists. They also may work for jazz ensembles, and are often used on overhead drums and close-miked piano.

Use two microphones mounted on a single stand with a stereo microphone stand adapter (such as the Shure A27M). Or mount 2 or 3 microphones on separate stands. Set the microphones in the desired stereo pickup arrangement (see below).

For sound reinforcement, stereo mic techniques are only warranted for a stereo sound system and even then, they are generally only effective for large individual instruments, such as piano or miramba, or small instrument groups, such as drum kit, string section or vocal chorus. Relatively close placement is necessary to achieve useable gain-before-feedback.

Coincident Techniques

Microphone diaphragms close together and aligned vertically; microphones angled apart.
Example: 135° angling (X-Y).

Comments

Tends to provide a narrow stereo spread (the reproduced ensemble does not always spread all the way between the pair of playback loud-speakers). Good imaging. Mono-compatible.



MS (Mid-Side)

A front-facing cardioid cartridge and a side-facing bidirectional cartridge are mounted in a single housing. Their outputs are combined in a matrix circuit to yield discrete left and right outputs.

Comments

Provides good stereo spread, excellent stereo imaging and localization. Some types allow adjustable stereo control. Mono-compatible.



Near-Coincident Techniques

Microphones angled and spaced apart 6 to 10 inches between grilles. Examples: 110° angled, 7-inch spacing

Comments

Tends to provide accurate image localization.



Spaced Techniques

Two microphones spaced several feet apart horizontally, both aiming straight ahead toward ensemble. Example: Microphones 3 to 10 feet apart.

Comments

Tends to provide exaggerated separation unless microphone spacing is 3 feet. However, spacing the microphones 10 feet apart improves overall coverage. Produces vague imaging for off-center sound sources. Provides a “warm” sense of ambience.

Musical Ensemble

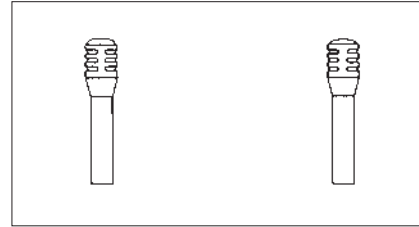

(Top View)

Three microphones spaced several feet apart horizontally, aiming straight ahead toward ensemble. Center microphone signal is split equally to both channels. Example: Microphones 5 feet apart.

Improved localization compared to two spaced microphones.

Musical Ensemble

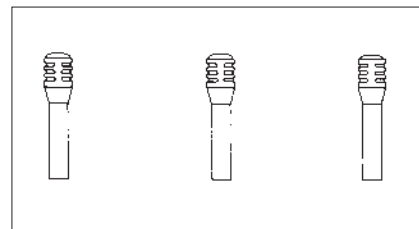

(Top View)

STEREO PICKUP SYSTEMS	MICROPHONE TYPES	MICROPHONE POSITIONS	
X-Y	2 - CARDIOID	AXES OF MAXIMUM RESPONSE AT 135° SPACING: COINCIDENT	
ORTF (FRENCH BROADCASTING ORGANIZATION)	2 - CARDIOID	AXES OF MAXIMUM RESPONSE AT 110° SPACING: NEAR-COINCIDENT (7 IN.)	
NOS (DUTCH BROADCASTING FOUNDATION)	2 - CARDIOID	AXES OF MAXIMUM RESPONSE AT 90° SPACING: NEAR-COINCIDENT (12 IN.)	
STEREOSONIC	2 - BIDIRECTIONAL	AXES OF MAXIMUM RESPONSE AT 90° SPACING: COINCIDENT	
MS (MID-SIDE)	1 - CARDIOID 1 - BIDIRECTIONAL	CARDIOID FORWARD-POINTED; BIDIRECTIONAL SIDE-POINTED; SPACING: COINCIDENT	
SPACED	2 - CARDIOID OR 2 - OMNIDIRECTIONAL	ANGLE AS DESIRED SPACING: 3-10 FT.	

Shure Microphone Selection Guide

Vocal

Live Vocals

KSM9
Beta58A
SM58
Beta54
Beta87A
Beta87C
SM87A
SM86
PG58
55SH Series II
WH30

Studio Vocals

KSM44
KSM32
KSM27
KSM9
SM7A
Beta87A
Beta87C
SM87A
SM86

Studio Ensemble Vocals

KSM44
KSM32
KSM27
KSM141
KSM137
KSM109

Live Choirs

MX202
EZO
SM81
SM94
PG81

Karaoke

SM58S
SM48S
565
PG58
PG48

Spoken Word

Beta53
SM48
PG48

Instrument

Studio Instrument

KSM141
KSM137
KSM109
KSM44
KSM32
KSM27
KSM81

Orchestra

KSM141
KSM137
KSM109
KSM44
KSM32
KSM27
SM81
SM94
PG81

Strings

KSM141
KSM137
KSM109
KSM44
KSM32
KSM27
SM81
SM94
PG81
Beta98S

Woodwinds

KSM44
KSM32
KSM27
KSM141
KSM137
KSM109
SM81
Beta98H/C
Beta98 S¹
PG81

Brass / Saxophone

Beta98H/C
KSM44
KSM32
KSM27
Beta57A
Beta98 S
Beta56 A
SM57
PG56
PG57

Acoustic Guitar

KSM141
KSM137
KSM109
KSM44
KSM32
KSM27
SM81
Beta57A
SM57
PG81
PG57

Acoustic Bass

KSM44
KSM32
KSM27
KSM141
KSM137
KSM109
Beta52A

SM81
SM94
PG81

Guitar Amp

Beta56A
Beta57A
SM57
KSM141
KSM137
KSM109
KSM44
KSM32
KSM27
SM94
PG57

Bass Amp

Beta52A
SM7B
Beta57A
Beta56A
SM57
PG52
SM94
PG57
PG81

Leslie Speaker

KSM44
KSM32
KSM27
Beta91
Beta57A
Beta56A
SM57

Piano / Organ

KSM44
KSM32
KSM27
KSM141
KSM137
KSM109
SM81
Beta91
PG81
SM94
MX202

Harmonica

520DX
SM57
SM58
PG57

Drum

Kick Drum

Beta52A
Beta91
PG52
Beta57A
SM57

Snare Drum²

Beta57A^{2,3}
Beta56A²
SM57^{2,3}
PG56
PG57^{2,3}

Rack / Floor Toms

Beta98D/S
Beta57A^{2,3}
Beta56A²
SM57^{2,3}
PG56
PG57^{2,3}

Congas

Beta98D/S
Beta56A²
Beta57A²
SM57²
PG56
PG57²

Cymbals

KSM141
KSM137
KSM109
KSM44
KSM32
KSM27
SM81
SM94
PG81

Other

Sampling / Effects

KSM44
KSM32
KSM27
KSM141
KSM137
KSM109
SM81
SM94
PG81
SM94

Live Stereo Recording

KSM141(pair)⁴
KSM137(pair)⁴
KSM109(pair)⁴
KSM44(pair)⁴
KSM32(pair)⁴
KSM27(pair)⁴
SM81(pair)⁴
SM94(pair)⁴
VP88
(M-S stereo)

Voice-Over

KSM44
KSM32
KSM27
SM7B
Beta58A
SM58
SM81⁵
Beta87C
Beta87A

1 Bell mounted with A98KCS clamp.

2 A56D enables microphone to mount on rim.

3 A50D enables microphone to mount on rim.

4 For optimum flexibility, use A27M stereo microphone mount.

5 With A81G.

Glossary

3-to-1 Rule-When using multiple microphones, the distance between microphones should be at least 3 times the distance from each microphone to its intended sound source.

Absorption-The dissipation of sound energy by losses due to sound absorbent materials.

Active Circuitry-Electrical circuitry which requires power to operate, such as transistors and vacuum tubes.

Ambience-Room acoustics or natural reverberation.

Amplitude-The strength or level of sound pressure or voltage.

Audio Chain-The series of interconnected audio equipment used for recording or PA.

Backplate-The solid conductive disk that forms the fixed half of a condenser element.

Balanced-A circuit that carries information by means of two equal but opposite polarity signals, on two conductors.

Bidirectional Microphone-A microphone that picks up equally from two opposite directions. The angle of best rejection is 90 deg. from the front (or rear) of the microphone, that is, directly at the sides.

Boundary/Surface Microphone-A microphone designed to be mounted on an acoustically reflective surface.

Cardioid Microphone-A unidirectional microphone with moderately wide front pickup (131 deg.). Angle of best rejection is 180 deg. from the front of the microphone, that is, directly at the rear.

Cartridge (Transducer)-The element in a microphone that converts acoustical energy (sound) into electrical energy (the signal).

Close Pickup-Microphone placement within 2 feet of a sound source.

Comb Filtering-An interference effect in which the frequency response exhibits regular deep notches.

Condenser Microphone-A microphone that generates an electrical signal when sound waves vary the spacing between two charged surfaces: the diaphragm and the backplate.

Critical Distance-In acoustics, the distance from a sound source in a room at which the direct sound level is equal to the reverberant sound level.

Current-Charge flowing in an electrical circuit. Analogous to the amount of a fluid flowing in a pipe.

Decibel (dB)-A number used to express relative output sensitivity. It is a logarithmic ratio.

Diaphragm-The thin membrane in a microphone which moves in response to sound waves.

Diffraction-The bending of sound waves around an object which is physically smaller than the wavelength of the sound.

Direct Sound-Sound which travels by a straight path from a sound source to a microphone or listener.

Distance Factor-The equivalent operating distance of a directional microphone compared to an omnidirectional microphone to achieve the same ratio of direct to reverberant sound.

Distant Pickup-Microphone placement farther than 2 feet from the sound source.

Dynamic Microphone-A microphone that generates an electrical signal when sound waves cause a conductor to vibrate in a magnetic field. In a moving-coil microphone, the conductor is a coil of wire attached to the diaphragm.

Dynamic Range-The range of amplitude of a sound source or the range of sound level that a microphone can successfully pick up.

Echo-Reflection of sound that is delayed long enough (more than about 50 msec.) to be heard as a distinct repetition of the original sound.

Electret-A material (such as Teflon) that can retain a permanent electric charge.

EQ-Equalization or tone control to shape frequency response in some desired way.

Feedback-In a PA system consisting of a microphone, amplifier, and loudspeaker feedback is the ringing or howling sound caused by amplified sound from the loudspeaker entering the microphone and being re-amplified.

Flat Response-A frequency response that is uniform and equal at all frequencies.

Frequency-The rate of repetition of a cyclic phenomenon such as a sound wave.

Frequency Response Tailoring Switch-A switch on a microphone that affects the tone quality reproduced by the microphone by means of an equalization circuit. (Similar to a bass or treble control on a hi-fi receiver.)

Frequency Response-A graph showing how a microphone responds to various sound frequencies. It is a plot of electrical output (in decibels) vs. frequency (in Hertz).

Fundamental-The lowest frequency component of a complex waveform such as musical note. It establishes the basic pitch of the note.

Gain-Amplification of sound level or voltage.

Gain-Before-Feedback-The amount of gain that can be achieved in a sound system before feedback or ringing occurs.

Harmonic-Frequency components above the fundamental of a complex waveform. They are generally multiples of the fundamental which establish the timbre or tone of the note.

Hypercardioid-A unidirectional microphone with tighter front pickup (105 deg.) than a supercardioid, but with more rear pickup. Angle of best rejection is about 110 deg. from the front of the microphone.

Impedance-In an electrical circuit, opposition to the flow of alternating current, measured in ohms. A high impedance microphone has an impedance of 10,000 ohms or more. A low impedance microphone has an impedance of 50 to 600 ohms.

Interference-Destructive combining of sound waves or electrical signals due to phase differences.

Inverse Square Law-States that direct sound levels increase (or decrease) by an amount proportional to the square of the change in distance.

Isolation-Freedom from leakage; ability to reject unwanted sounds.

Leakage-Pickup of an instrument by a microphone intended to pick up another instrument. Creative leakage is artistically favorable leakage that adds a “loose” or “live” feel to a recording.

NAG-Needed Acoustic Gain is the amount of gain that a sound system must provide for a distant listener to hear as if he or she was close to the unamplified sound source.

Noise-Unwanted electrical or acoustic interference.

Noise Canceling-A microphone that rejects ambient or distant sound.

NOM-Number of open microphones in a sound system. Decreases gain-before-feedback by 3dB everytime NOM doubles.

Omnidirectional Microphone-A microphone that picks up sound equally well from all directions.

Overload-Exceeding the signal level capability of a microphone or electrical circuit.

PAG-Potential Acoustic Gain is the calculated gain that a sound system can achieve at or just below the point of feedback.

Phantom Power-A method of providing power to the electronics of a condenser microphone through the microphone cable.

Phase-The “time” relationship between cycles of different waves.

Pickup Angle / Coverage Angle-The effective arc of coverage of a microphone, usually taken to be within the 3dB down points in its directional response.

Pitch-The fundamental or basic frequency of a musical note.

Polar Pattern (Directional Pattern, Polar Response)-A graph showing how the sensitivity of a microphone varies with the angle of the sound source, at a particular frequency. Examples of polar patterns are unidirectional and omnidirectional.

Polarization-The charge or voltage on a condenser microphone element.

Glossary

Pop Filter-An acoustically transparent shield around a microphone cartridge that reduces popping sounds. Often a ball-shaped grille, foam cover or fabric barrier.

Pop-A thump of explosive breath sound produced when a puff of air from the mouth strikes the microphone diaphragm. Occurs most often with “p,” “t,” and “b” sounds.

Presence Peak-An increase in microphone output in the “presence” frequency range of 2000 Hz to 10,000 Hz. A presence peak increases clarity, articulation, apparent closeness, and “punch.”

Proximity Effect-The increase in bass occurring with most unidirectional microphones when they are placed close to an instrument or vocalist (within 1 ft.). Does not occur with omnidirectional microphones.

Rear Lobe-A region of pickup at the rear of a supercardioid or hypercardioid microphone polar pattern. A bidirectional microphone has a rear lobe equal to its front pickup.

Reflection-The bouncing of sound waves back from an object or surface which is physically larger than the wavelength of the sound.

Refraction-The bending of sound waves by a change in the density of the transmission medium, such as temperature gradients in air due to wind.

Resistance-The opposition to the flow of current in an electrical circuit. It is analogous to the friction of fluid flowing in a pipe.

Reverberation-The reflection of a sound a sufficient number of times that it becomes non-directional and persists for some time after the source has stopped. The amount of reverberation depends on the relative amount of sound reflection and absorption in the room.

Rolloff-A gradual decrease in response below or above some specified frequency.

Sensitivity-The electrical output that a microphone produces for a given sound pressure level.

Shaped Response-A frequency response that exhibits significant variation from flat within its range. It is usually designed to enhance the sound for a particular application.

Sound Chain-The series of interconnected audio equipment used for recording or PA.

Sound Reinforcement-Amplification of live sound sources.

Speed of Sound-The speed of sound waves, about 1130 feet per second in air.

SPL-Sound Pressure Level is the loudness of sound relative to a reference level of 0.0002 microbars.

Standing Wave-A stationary sound wave that is reinforced by reflection between two parallel surfaces that are spaced a wavelength apart.

Supercardioid Microphone-A unidirectional microphone with tighter front pickup angle (115 deg.) than a cardioid, but with some rear pickup. Angle of best rejection is 126 deg. from the front of the microphone, that is, 54 deg. from the rear.

Timbre-The characteristic tone of a voice or instrument; a function of harmonics.

Transducer-A device that converts one form of energy to another. A microphone transducer (cartridge) converts acoustical energy (sound) into electrical energy (the audio signal).

Transient Response-The ability of a device to respond to a rapidly changing input.

Unbalanced-A circuit that carries information by means of one signal on a single conductor.

Unidirectional Microphone-A microphone that is most sensitive to sound coming from a single direction in front of the microphone. Cardioid, supercardioid, and hypercardioid microphones are examples of unidirectional microphones.

Voice Coil-Small coil of wire attached to the diaphragm of a dynamic microphone.

Voltage-The potential difference in an electric circuit. Analogous to the pressure on fluid flowing in a pipe.

Wavelength-The physical distance between the start and end of one cycle of a soundwave.

Microphone Techniques for **LIVE SOUND**

Rick Waller

Now residing in the Chicago area, Rick grew up near Peoria, Illinois. An interest in the technical and musical aspects of audio has led him to pursue a career as both engineer and musician. He received a BS degree in Electrical Engineering from the University of Illinois at Urbana/Champaign, where he specialized in acoustics, audio synthesis and radio frequency theory. Rick is an avid keyboardist, drummer and home theater hobbyist and has also worked as a sound engineer and disc jockey. Currently he is an associate in the Applications Engineering Group at Shure Incorporated. In this capacity Rick provides technical support to domestic and international customers, writing and conducting seminars on wired and wireless microphones, mixers and other audio topics.

John Boudreau

John, a lifelong Chicago native, has had extensive experience as a musician, a recording engineer, and a composer. His desire to better combine the artistic and technical aspects of music led him to a career in the audio field.

Having received a BS degree in Music Business from Elmhurst College, John performed and composed for both a Jazz and a Rock band prior to joining Shure Incorporated in 1994 as an associate in the Applications Engineering group. At Shure, John led many audio product training seminars and clinics, with an eye to helping musicians and others affiliated with the field use technology to better fulfill their artistic interpretations.

No longer a Shure associate, John continues to pursue his interests as a live and recorded sound engineer for local bands and venues, as well as writing and recording for his own band.

Tim Vear

Tim is a native of Chicago who has come to the audio field as a way of combining a lifelong interest in both entertainment and science. He has worked as an engineer in live sound, recording and broadcast, has operated his own recording studio and sound company, and has played music professionally since high school.

At the University of Illinois, Urbana-Champaign, Tim earned a BS in Aeronautical and Astronautical Engineering with a minor in Electrical Engineering. During this time he also worked as chief technician for both the Speech and Hearing Science and Linguistics departments.

In his tenure at Shure Incorporated, Tim has served in a technical support role for the sales and marketing departments, providing product and applications training for Shure customers, dealers, installers, and company staff. He has presented seminars for a variety of domestic and international audiences, including the National Systems contractors Association, the Audio Engineering Society and the Society of Broadcast Engineers. Tim has authored several publications for Shure Incorporated and his articles have appeared in Recording Engineer/Producer, Live Sound Engineering, Creator, and other publications.

Additional Shure Publications Available:

Printed or electronic versions of the following guides are available free of charge.

To obtain your complimentary copies, call one of the phone numbers listed below or visit www.shure.com.

- Selection and Operation of Wireless Microphone Systems
- Audio Systems Guide for Video Production
- Audio Systems Guide for Houses of Worship
- Microphone Techniques for Studio Recording

Our Dedication to Quality Products

Shure offers a complete line of microphones and wireless microphone systems for everyone from first-time users to professionals in the music industry—for nearly every possible application.

For over eight decades, the Shure name has been synonymous with quality audio.

All Shure products are designed to provide consistent, high-quality performance under the most extreme real-life operating conditions.



United States:
Shure Incorporated
5800 West Touhy Avenue
Niles, IL 60714-4608 USA

Phone: 847-600-2000
Fax: 847-600-1212
Email: info@shure.com

Europe, Middle East, Africa:
Shure Europe GmbH
Wannenäckerstr. 28,
74078 Heilbronn, Germany

Phone: 49-7131-72140
Fax: 49-7131-721414
Email: info@shure.de

Asia, Pacific:
Shure Asia Limited
3/F, Citicorp Centre
18 Whitfield Road
Causeway Bay, Hong Kong

Phone: 852-2893-4290
Fax: 852-2893-4055
Email: info@shure.com.hk

**Canada, Latin America,
Caribbean:**
Shure Incorporated
5800 West Touhy Avenue
Niles, IL 60714-4608 USA

Phone: 847-600-2000
Fax: 847-600-6446
Email: international@shure.com